

## Screw Plug Immersion Heaters

### Overview

#### Description

Screw Plug Immersion Heaters consist of hairpin bent tubular elements brazed or welded into a screw plug and provided with terminal enclosures for electrical connections. Screw Plug Immersion Heaters are screwed directly through a threaded opening in a tank wall or through a matching pipe coupling or half coupling. Sizes of screw plug heaters are available with 1/2, 3/4, 1, 1-1/4, 2 and 2-1/2" pipe threads. A wide selection of screwplug sizes, kilowatt ratings, voltages, sheath materials, terminal enclosures and thermostats makes these compact heaters ideal for all types of applications.

#### Applications

Screw Plug Immersion Heaters are used for heating liquids and gases in a variety of processes. These heaters are ideal for process water heating and freeze protection. All types of oils and heat transfer solutions can also be heated using these compact, easily controlled units. The direct immersion method is energy efficient and well suited for many applications.

- Hot Water Storage Tanks
- Warming Equipment
- Preheating all Grades of Oil
- Food Processing Equipment
- Cleaning and Rinsing Tanks
- Heat Transfer Systems
- Process Air Equipment
- Boiler Equipment
- Freeze Protection of Any Fluid

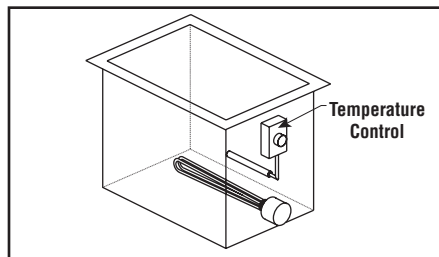

**MT** — screwed into tank wall parallel to bottom for use as a hot water rinse.

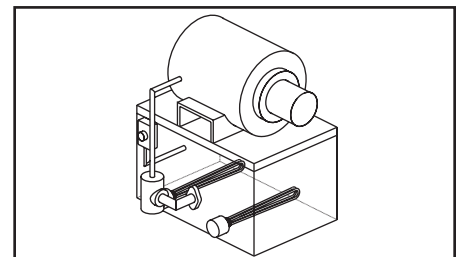

**MTO** — used to preheat oil to ensure efficient lubrication for heavy motor.

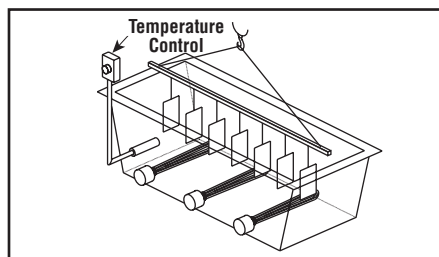

**MTO** — applied to conveyorized degreasing operation of many parts at once.



*More Information  
is Available Online  
on Tank Heating. Book-  
mark Your Browser to*  
**[www.chromalox.com](http://www.chromalox.com)** and Select  
**Manuals**

## Screw Plug Immersion Heaters Selection Guidelines

### Selecting a Screw Plug Heater

The selection of the proper screw plug immersion heater requires critical engineering judgement. After determining the heat requirement (see the Technical section of this catalog), the proper selection of the screw plug material, heating element sheath material and correct watt density is critical for long life of the heater. The following table may be used as a guide to this selection, along with the Technical Information at the back of this catalog. Ultimate choice is determined by the knowledge of the process and engineering acumen of the plant engineer.

### Application Factors

Heater application is influenced by the following parameters.

- ① The heated media, viscosity, specific heat, density and corrosive properties.
- ② Contaminants or pH present in the media.
- ③ The corrosion resistant properties of heater sheath material.
- ④ Watt density of the heating element—the heat output per square inch.
- ⑤ Screw plug material.

### Typical Applications

See screw plug immersion heater selection guide below for your application.

- Hot Water Storage Tanks
- Warming Equipment
- Preheating all Grades of Oil
- Food Processing Equipment
- Cleaning and Rinsing Tanks
- Heat Transfer Systems
- Process Air Equipment
- Boiler Equipment
- Freeze Protection of Any Fluid

### Screw Plug Immersion Heaters — Selection Guidelines

	①	②	③	④	⑤
Application	Solution or Heater Type	Alkaline or Acid Content (Est. % by Volume)	Sheath Material	Watt Density (W/In <sup>2</sup> )	Screw Plug Material
Water & Very Mild Solutions	Clean Water	pH6 to pH8 Neutral	Copper	45	Brass
	Process Water or Very Weak Solutions	pH5 to pH9 2-3%	Stainless Steel <sup>1</sup>	45	Stainless Steel
	Weak Solutions	5-6%	INCOLOY®	45	Stainless Steel
	Demineralized, Deionized water	—	INCOLOY® Stainless Steel <sup>1</sup>	45	Stainless Steel Stainless Steel
Corrosive & High Viscous Solutions	Mild Corrosive Solution	5-15%	INCOLOY® or Stainless Steel <sup>1</sup>	23	Stainless Steel
	Severe Corrosive Solution	16% or more	INCOLOY®, Stainless Steel or Titanium	15	Stainless Steel
Oil Heating	Low Viscosity Oil	—	Steel	23	Steel
	Medium Viscosity Oil	—	Steel	15	Steel
	High Viscosity Oil	—	Steel	6	Steel
Specialty Heaters	Small Tanks				Brass
	Process Water	pH5 to pH9	Stainless Steel <sup>1</sup>	45	Stainless Steel
	Demineralized Water	—	Stainless Steel	23	Steel
	Low Viscosity Oil	—	INCOLOY®	12	Steel
	Pipe Insert Commercial Equipment	Clean Water	Copper	60	Brass

1. Passivated stainless steel recommended for water applications.

**Note** — Liquid level controls are suggested for all immersion heating applications. See Controls section in this catalog.

 **More Information**  
is Available Online  
on Tank Heating.

Bookmark Your Browser to  
[www.chromalox.com](http://www.chromalox.com)  
and Select **Manuals**.

**Chromalox**®

## Screw Plug Immersion Heaters

### Application Element Guidelines

Application	Screw Plug Size (In.)	Sheath Material	Screw Plug Material	Heater Model	Integral Thermostat	Page
Clean Water	1	Copper	Brass	ARTM	Yes	B-7
	1	Copper	Brass	MT	No	B-8
	1-1/4	Copper	Brass	ARMT-1	No	B-9
	1-1/4	Copper	Brass	MT-1	No	B-10
	2	Copper	Brass	EMT-3	No	B-15
	2	Copper	Brass	ARMT-2	Yes	B-11
	2	Copper	Brass	MT-2	No	B-13
	2	INCOLOY®	Brass	CH-SD	No	B-16
	2-1/2	Copper	Brass	ARMT-3	Yes	B-17
2-1/2	Copper	Brass	MT-3	No	B-21	
Process Water	1	SS	SS	ARTMS	Yes	B-23
	1	SS	SS	MTS	No	B-24
	1-1/4	SS	SS	ARMTS-1	Yes	B-25
	1-1/4	SS	SS	MTS-1	No	B-26
	2	SS	SS	ARMTS-2	Yes	B-27
	2	SS	SS	MTS-2	No	B-29
	2	SS	SS	AREMTS-3	Yes	B-31
	2	SS	SS	EMTS-3	No	B-32
	2-1/2	SS	SS	ARMTS-3	Yes	B-34
2-1/2	SS	SS	MTS-3	No	B-36	
Solution Water	2	INCOLOY®	SS	ARMTI-2	Yes	B-38
	2	INCOLOY®	SS	MTI-2	No	B-40
	2	INCOLOY®	SS	AREMTI-3	Yes	B-41
	2	INCOLOY®	SS	EMTI-3	No	B-42
	2-1/2	INCOLOY®	SS	ARMTI-3	Yes	B-43
	2-1/2	INCOLOY®	SS	MTI-3	No	B-45
Corrosive Solutions	2	SS	SS	AREMTS-3	Yes	B-46
	2	SS	SS	EMTS-3	No	B-47
	2	INCOLOY®	SS	AREMTI-3	Yes	B-48
	2	INCOLOY®	SS	EMTI-3	No	B-49
Severely Corrosive Solutions	2	SS	SS	AREMTS-3	Yes	B-50
	2	SS	SS	EMTS-3	No	B-51
	2	INCOLOY®	SS	AREMTI-3	Yes	B-52
	2	INCOLOY®	SS	EMTI-3	No	B-53
Light Weight Oil	1	Steel	Steel	ARMTO	Yes	B-54
	1	Steel	Steel	MTO	No	B-55
	1	Steel	Steel	ARTMO-1	Yes	B-56
	1-1/4	Steel	Steel	MTO-1	No	B-57
	2	Steel	Steel	ARMTO-2	Yes	B-58
	2	Steel	Steel	MTO-2	No	B-60
	2	Steel	Steel	AREMTO-3	Yes	B-61
	2	Steel	Steel	EMTO-3	No	B-62
	2-1/2	Steel	Steel	ARMTO-3	Yes	B-63
2-1/2	Steel	Steel	MTO-3	No	B-65	
Medium Weight Oil	2	Steel	Steel	ARMTO-2	Yes	B-67
	2	Steel	Steel	MTO-2	No	B-68
	2	Steel	Steel	AREMTO-3	Yes	B-69
	2	Steel	Steel	EMTO-3	No	B-70
	2-1/2	Steel	Steel	ARMTO-3	Yes	B-71
	2-1/2	Steel	Steel	MTO-3	No	B-72
Heavy Weight Oil	2	Steel	Steel	ARMTO-2	Yes	B-73
	2	Steel	Steel	MTO-2	No	B-74
	2	Steel	Steel	AREMTO-3	Yes	B-73
	2	Steel	Steel	EMTO-3	No	B-74
	2-1/2	Steel	Steel	ARMTO-3	Yes	B-75
	2-1/2	Steel	Steel	MTO-3	No	B-75
Specialty Heaters — Water, Oil & Corrosive Fluids	1/2	INCOLOY®	Steel	RI	No	B-79
	1/2	SS	Steel	RIO	No	B-79
	1/2	INCOLOY®	Brass	RIN	No	B-80
	1/2	SS	Brass	RINO	No	B-80
	1/2	SS	SS	RIS	No	B-79
	3/4	INCOLOY®	Brass	RIN	No	B-80
	3/4	SS	Brass	RINO	No	B-80
	1	Copper	Brass	TMW-1	No	B-76
	1	Copper	Steel	TM-1	No	B-78
	1	SS	SS	TMWS-1	No	B-76
	1	Steel	Steel	TMO-1	No	B-78
	1-1/4	Copper	Brass	TMW-2	No	B-77
	2	INCOLOY®	Brass	DWH-MR	Yes	B-81
	2	INCOLOY®	Steel	MTO-LT	No	B-82
	2-1/2	INCOLOY®	Steel	VTS	Yes	B-83
	2-1/2	—	Various	IL-3S	Yes	B-83

**Note** — SS denotes 304 Stainless Steel.

## Screw Plug Immersion Heaters

### Technical & Application Data

#### Description

Chromalox heavy duty tubular elements are welded or brazed to a screw plug. Uniform heat distribution and repressed element bends, a Chromalox standard feature, lead to long element life. For all heaters, a thermowell (hollow tube sealed at one end) is welded or brazed to the screw plug allowing thermostat sensing element replacement without draining the tank. A variety of methods of terminating power leads is available for special application heaters.

General purpose screw plug heaters are equipped with a steel terminal enclosure painted with red polyester powder coat. These same heaters are also available with a combination moisture tight/explosion resistant terminal enclosure that may be used in applications where either or both conditions exist.

Screw plug type heaters are screwed directly through a threaded opening in the tank wall. Heavy tank walls may be drilled and tapped if thickness is sufficient to engage 3/4 of the threads. Lighter tank walls should be equipped with a suitable pipe half-coupling welded or brazed to the tank wall.

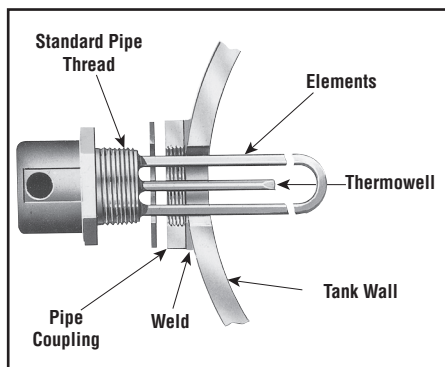

#### Construction Features — Stock & Assembly Stock Units

##### Element

- **Materials** — copper, steel, INCOLOY®, 304 stainless steel.
- **Number Elements in Screw Plug** — 1, 2 or 3 depending on screw plug size.
- **Element Diameter** — 0.315, 0.375, 0.430 and 0.475".
- **Watt Density** — 6.5, 15, 23, 45 and 75 W/In<sup>2</sup>.

##### Screw Plug

- **Materials** — carbon steel, brass, 304 stainless steel.
- **Size** — 1/2, 3/4, 1, 1-1/4, 2, 2-1/2" NPT nominal.
- **Tolerances** — Tolerance on immersion length (B) dimension is  $\pm 1\%$  ( $\pm 3/8"$  min.).

##### Terminal Enclosures

**Type E1** General purpose, sheet metal, painted with red polyester powder coat. The terminal enclosure rotates 360° to accommodate an electrical conduit run.

**Type E4** Moisture resistant housing.

**Type E2** Combination moisture resistant/explosion resistant.

**Type E2** explosion resistant enclosures are for use in hazardous location conditions:

- Class I Groups B, C & D, Division 1 & 2\*
- Class II, Groups E, F & G, Division 1 & 2
- Class III, Division 1 & 2

Safe operation of heaters equipped with explosion resistant enclosures depends on electrical wiring meeting the National Electrical Code for hazardous locations and on limiting the maximum operating temperatures (including temperatures on outside of vessel, piping, flanges, screw plugs, enclosures and other heat conducting parts) as dictated by flammable liquids, vapors or gases present. Approved pressure and/or temperature limiting controls must be used to assure safe operation in the event of a system malfunction.

The 'C' and 'US' indicators adjacent to the CSA mark signify that the product has been evaluated to the applicable CSA and ANSI/UL standards, for use in Canada and the U.S., respectively. This 'US' indicator includes products eligible to bear the 'NRTL' indicator. NRTL, i.e. National Recognized Testing Laboratory, is a designation granted by the U.S. Occupational Safety and Health Administration (OSHA) to laboratories which have been recognized to perform certification to U.S. standards.

##### Temperature Controls

Many screw plug type heaters are available with built-in thermostatic controls. In some installations where there is more than one heater in a tank, one heater with a built-in control can be used to control the other heaters by wiring the thermostat into the holding coil circuit of a magnetic contactor. If the thermostat is separate from the heater, the thermostat sensing element should be located in the liquid approximately 4 to 6 inches above the heater.

**1 and 1-1/4" Screw Plugs** — Type ARTM, ARTMO and ARTMS. The ARTM, ARTMO or ARTMS automatic thermostat has a temperature range of 60°F - 187°F (T4). Also available with alternate temperature 60°F - 240°F (T5) or 0°F - 127°F (T8). The tamper resistant temperature adjustment screw and scale are inside requiring the removal of the cover to change temperature setting.

**2 and 2-1/2" Screw Plugs** — Type ARMT, ARMTI, AREMTI, ARMTS, AREMTS, AREMTO and ARMTO. The integral thermostat is available with temperature ranges at 60°F - 250°F (T2) or 0°F - 100°F (T1) for ARMT, ARMTI, AREMTI, AREMTS and ARMTS heaters. ARMTO and AREMTO heaters are available with three different temperature ranges: 200°F - 550°F (T3), 60°F - 250°F (T2) and 0°F - 100°F (T1). This control is wired in as a line thermostat for loads up to 3 kW on 120 volts and up to 6 kW on 240 volts. For higher wattage ratings, three phase operation and above 240 volts, this control is used for pilot duty only and should be wired to operate the holding coil of a magnetic contactor.

To set the control temperature of heaters equipped with the standard general purpose enclosure (Type E1), adjust the knob on the outside of the terminal enclosure.

For those heaters equipped with a Type E2 and E4 enclosure, remove the terminal enclosure lid to expose the temperature adjusting knob. For safety reasons, power to heater and pilot duty power must be turned off before removing enclosure lid.

**Note** — The integral thermostat functions as a temperature control only. This is not a fail safe device, so an approved pressure and/or temperature limit control should be used with these heaters to assure safe operation.

**CAUTION** — Explosion Resistant Type E2 construction refers to heater design features which provide explosion resistant containment of electrical wiring according to National Electrical Code. Application or use of heaters which result in abnormal or excessive temperature can create hazardous conditions which can lead to a fire or explosive condition.

##### Corrosion Policy

Chromalox cannot warrant any electric immersion heater against failure by sheath corrosion if such failure is the result of operating conditions beyond the control of the heater manufacturer. It is the responsibility of the purchaser to make the ultimate choice of sheath material based on their knowledge of the chemical composition of the corrosive solution, character of materials entering the solution, and controls which he maintains on the process.

\* For EMT and MT Class I Group B, Div. 1 & 2, consult factory.



## Screw Plug Immersion Heaters

### Optional Features

#### *Moisture Resistant Terminal Enclosure Option*

- Cast Aluminum Construction
- Red Polyester Powder Coat
- O-Ring Sealed Housing Cover
- Threaded 3/4" NPT Conduit Fitting

#### *Description*

A moisture resistant only (not explosion resistant) terminal enclosure is available on all screw plug immersion heaters.

#### *To Order*

Add E4 to end of model number of the general purpose enclosure heater for moisture resistant construction only. Specify volts, phase and kilowatts. **Do not order by PCN.**

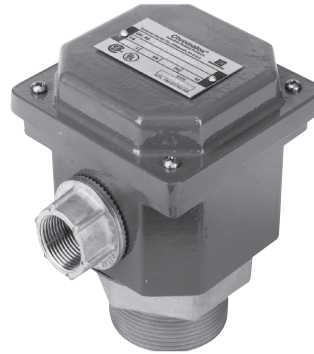

#### *Small Screw Plug Enclosure — Dimensions (Inches)*

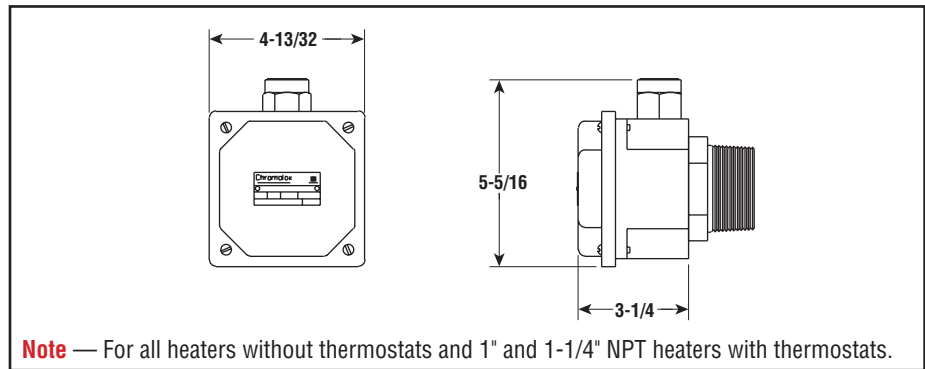

#### *Large Screw Plug Enclosure — Dimensions (Inches)*

